

drawn left (right mirrorimage)

dimensions without coating / maximum coating allowed 0.1mm

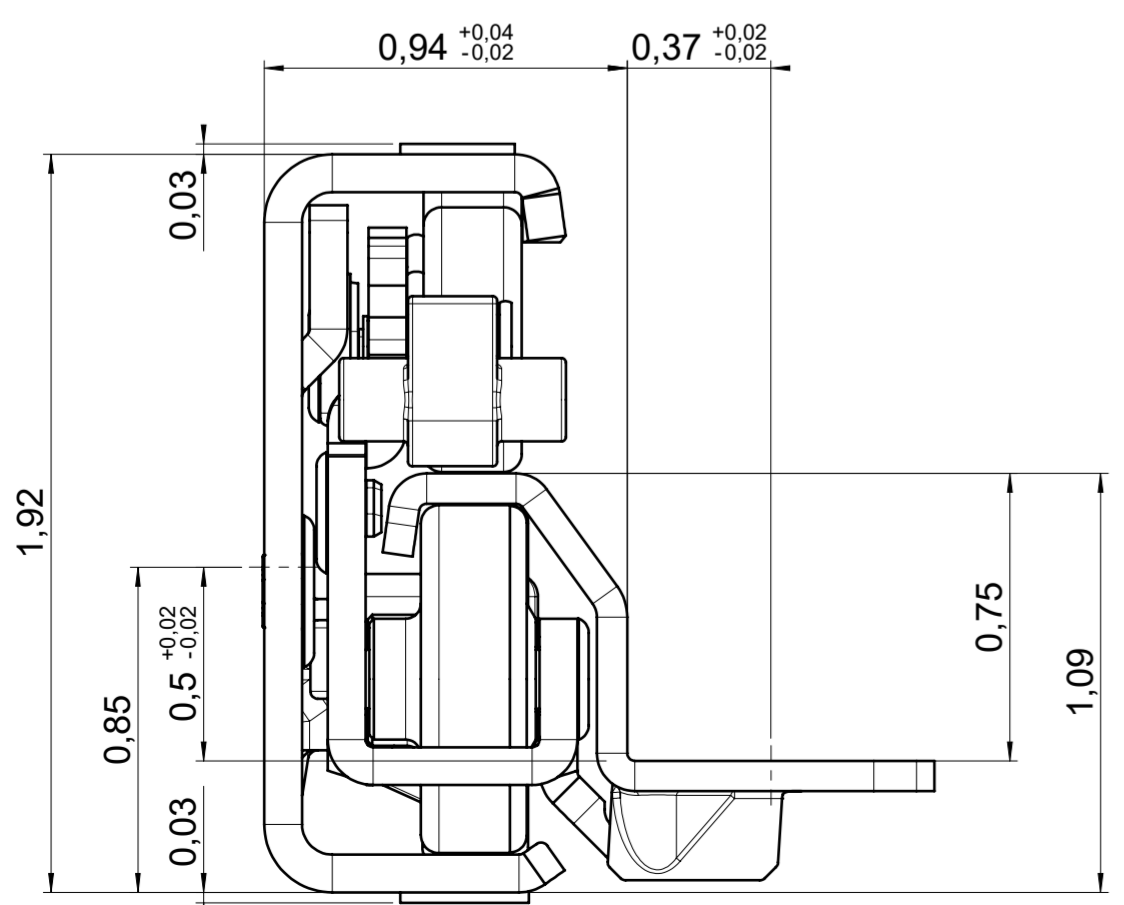
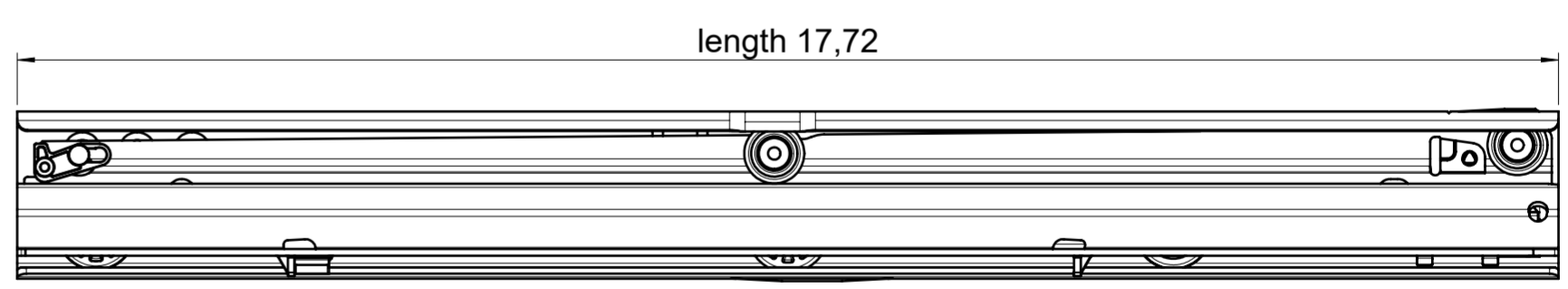
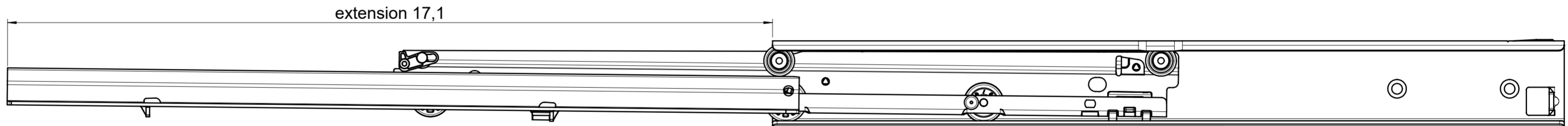
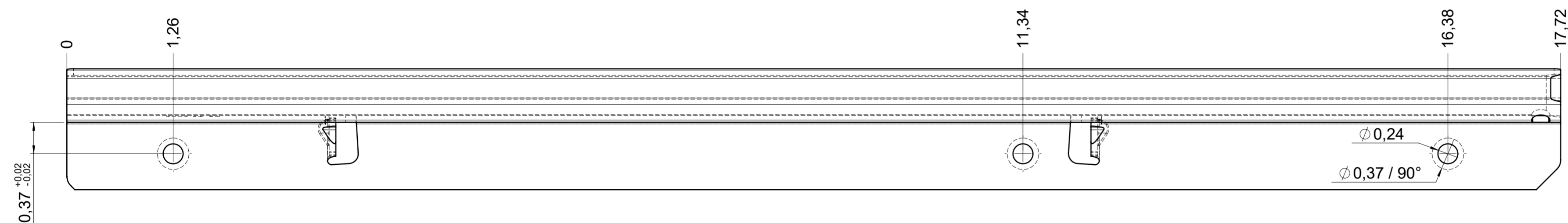
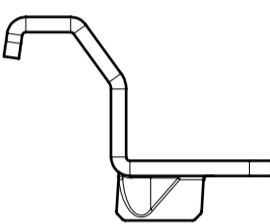
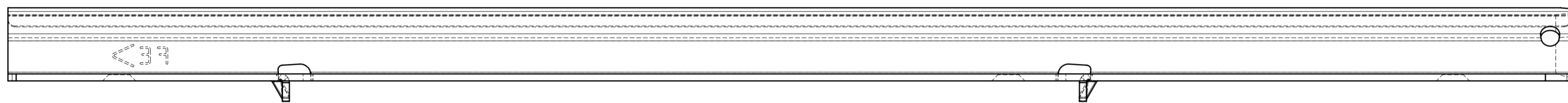
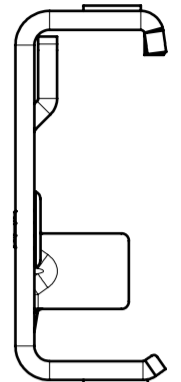
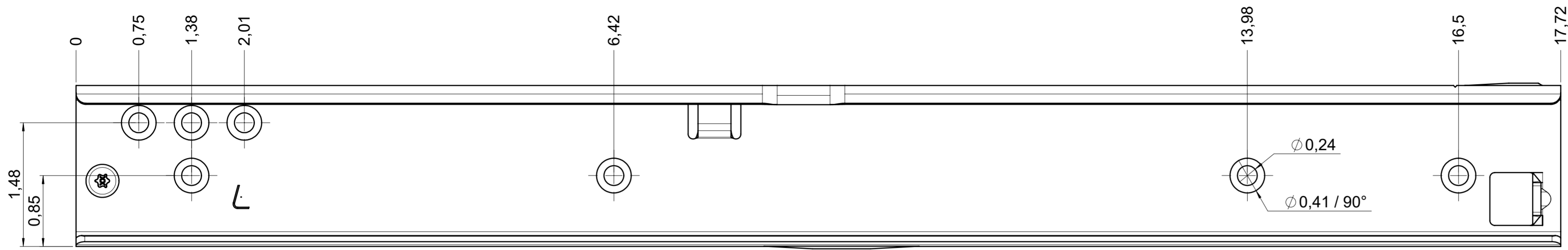

final approval

customer name:

signed by:

date:

all dimensions in inch			DIN ISO 128-30 missing dimensions see 3D = theor. intersection	
This drawing remains our property and may not be multiplied neither be disclosed to third parties (§§1,3 and 5 from the copyright Act (UrhG)) covered according to DIN ISO 16016				
scale: 1:1		surface:		material, semi finished parts: steel (technical requirements Fulterer)
drawn 29-11-2022		date 29-11-2022		name BM
proven 00-00-0000		date 00-00-0000		description: FR 7075 / 45 EN (inch) progressive-action full-extension drawerslide / bottom mount
			drawing number: 7075.450-GA.0000	
Fulterer AG & Co KG A-6890 Lustenau / Austria Fulterer AG CH-9430 St. Margrethen			replaces version date:	
ind.	changes	date	na.	