

SCALE 1:1

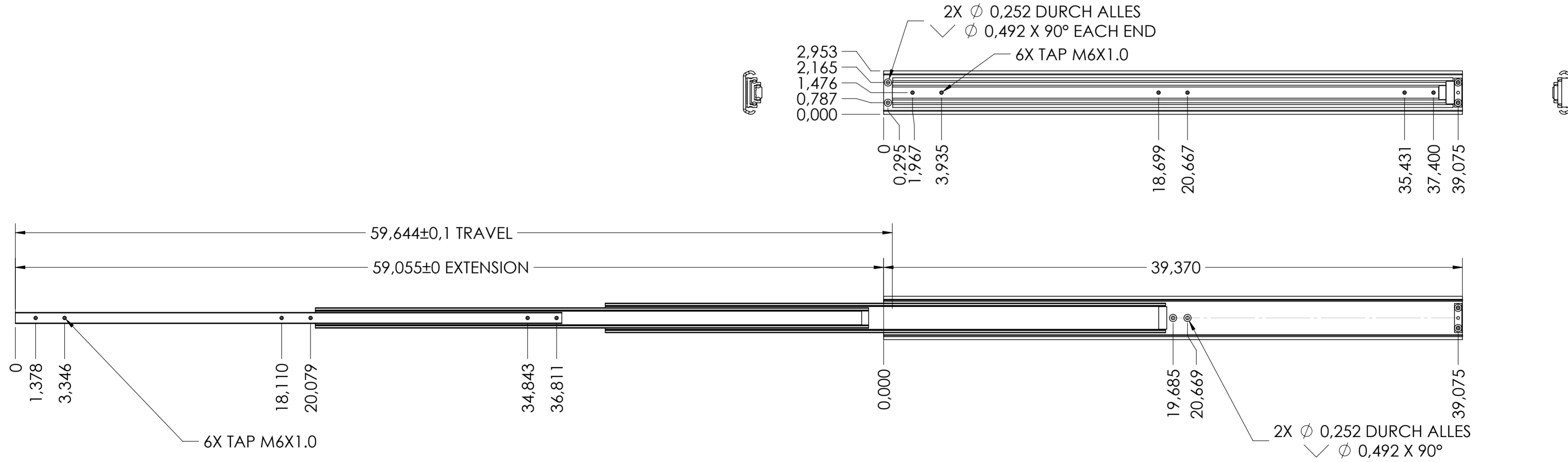

RECOMMENDED HARDWARE:
 CABINET- M6 FLAT HEAD SCREWS
 (2) REAR SCREWS ARE 12mm LONGER THAN FRONT/MIDDLE LOCATIONS
 DRAWER- M6 x 1.0 SCREWS

general tolerances		DIN ISO 128-30	
ISO 2768-m		missing dimensions see 3D = theor. intersection	
This drawing remains our property and may not be multiplied neither be disclosed to third parties (§§1,3 and 5 from the copyright Act (UrhG))			
covered according to DIN ISO 16016		scale:	surface:
(k)		1:5	
(l)		date	name
(m)		drawn 17-12-2018	HB
(n)		proven 00-00-0000	00
(o)		Fulterer	
(p)			
(q)		Fulterer AG & Co KG	
(r)		A-6890 Lustenau / Austria	
(s)		Fulterer AG	
(t)		CH-9430 St. Margrethen	
(u)		drawing number:	
(v)		5432.1000-GA.T093	
(w)		replaces version date:	
(x)			
(y)			
(z)			
ind.	changes	date	na.