

SCALE 1:1

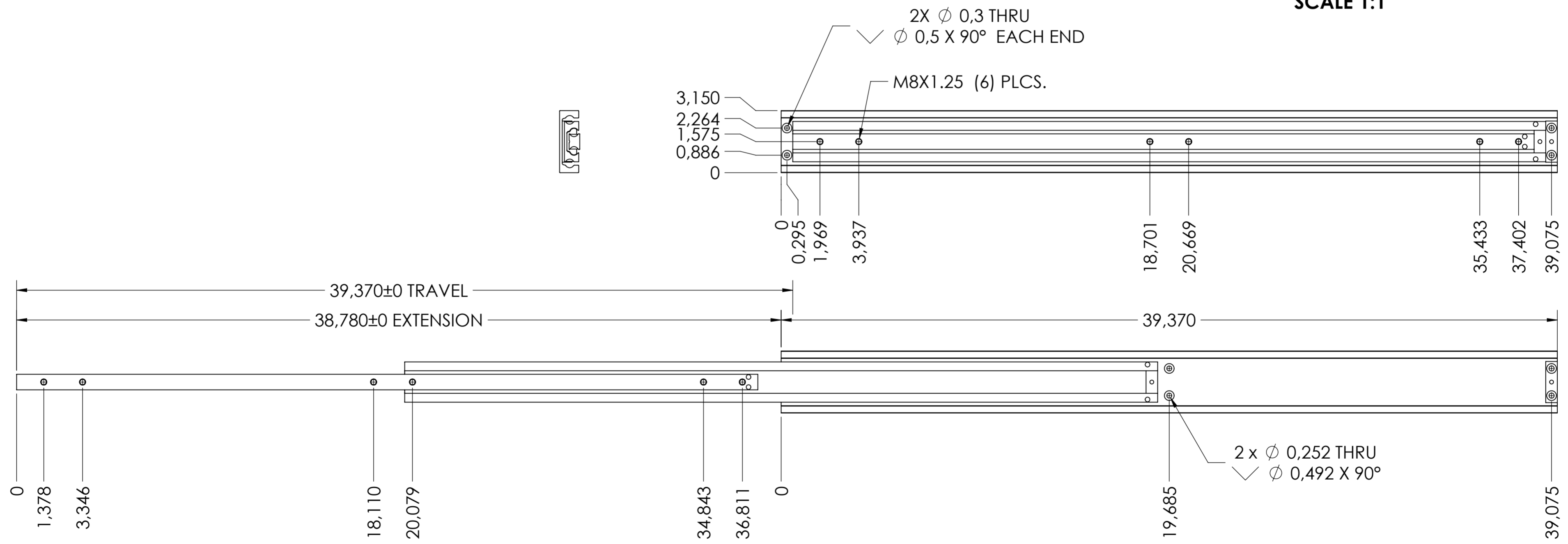

RECOMMENDED HARDWARE:
 CABINET- M6 FLAT HEAD SCREWS
 (2) REAR SCREWS 12mm LONGER THAN FRONT/MIDDLE LOCATIONS
 DRAWER- M8 x 1.25 SCREWS

general tolerances		DIN ISO 128-30 missing dimensions see 3D = theor. intersection	
ISO 2768-m			
This drawing remains our property and may not be multiplied neither be disclosed to third parties (§§1,3 and 5 from the copyright Act (UrhG)) covered according to DIN ISO 16016			
scale: 1:4		surface: ALUMINUM (technical requirements Fulterer)	
drawn: 20-07-2018 HB		description: FULL EXTENSION SIDE MOUNT SUPER HEAVY DUTY ALUMINUM SLIDE	
proven: 00-00-0000 00		drawing number: 5826.1000-GA.T094	
Fulterer		replaces version date:	
Fulterer AG & Co KG A-6890 Lustenau / Austria		drawing number: 5826.1000-GA.T094	
Fulterer AG CH-9430 St. Margrethen		replaces version date:	
ind.	changes	date	na.