

drawn left (right mirrorimage)

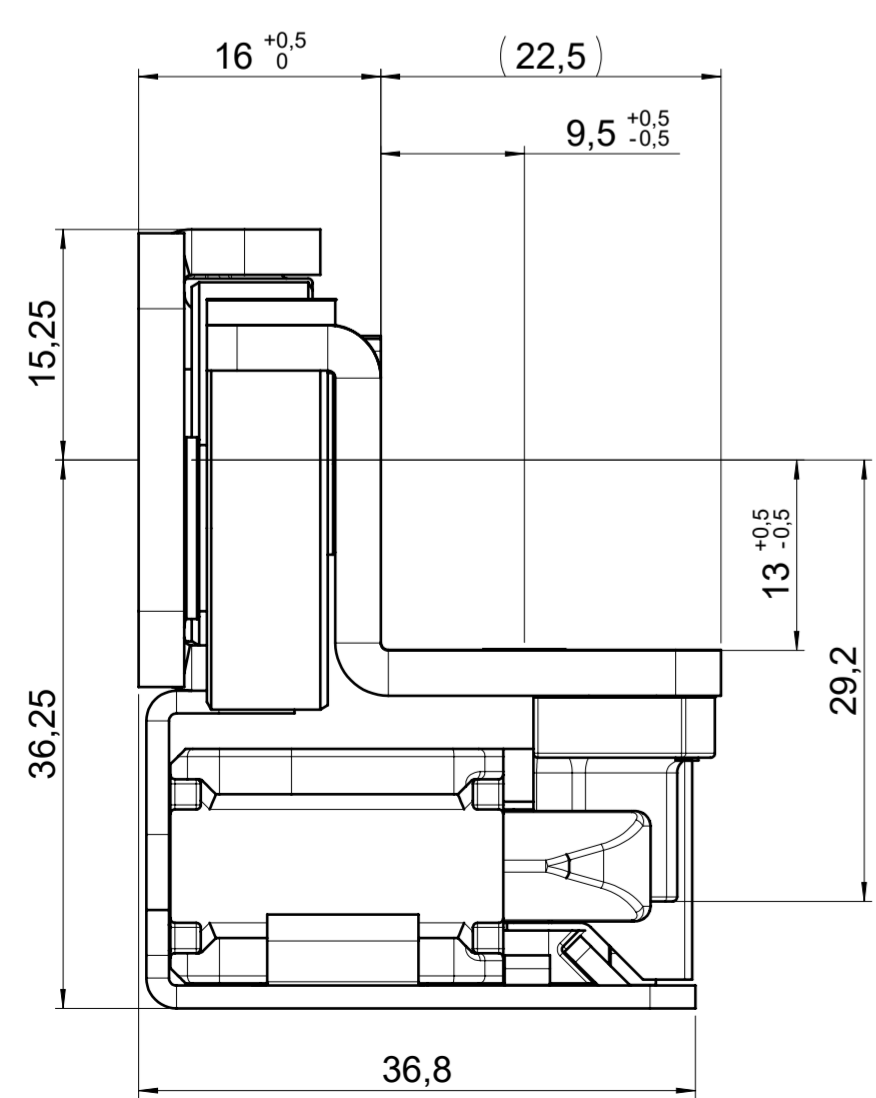

left with ECD

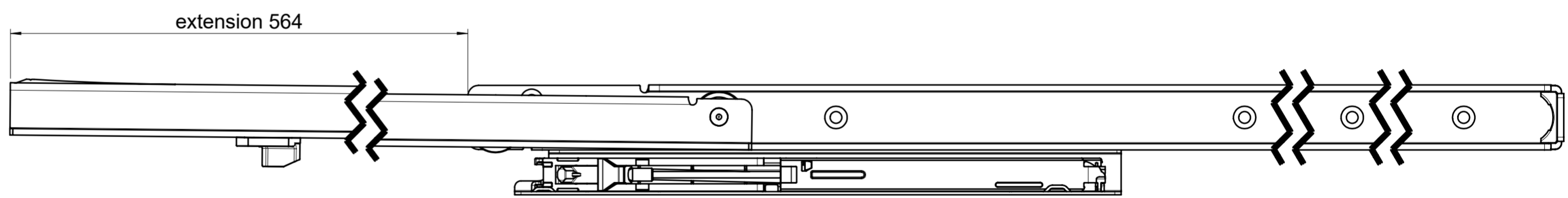
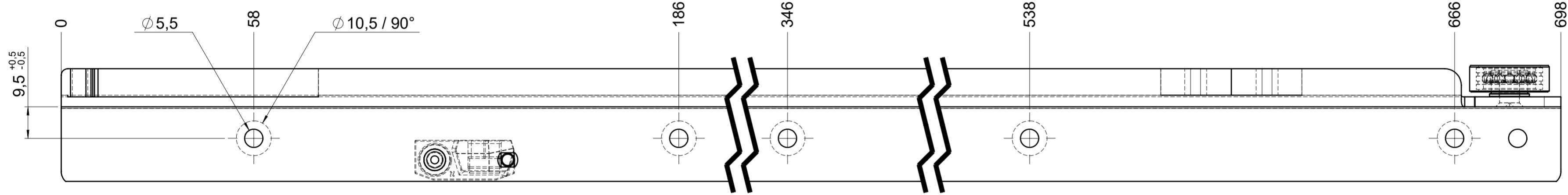
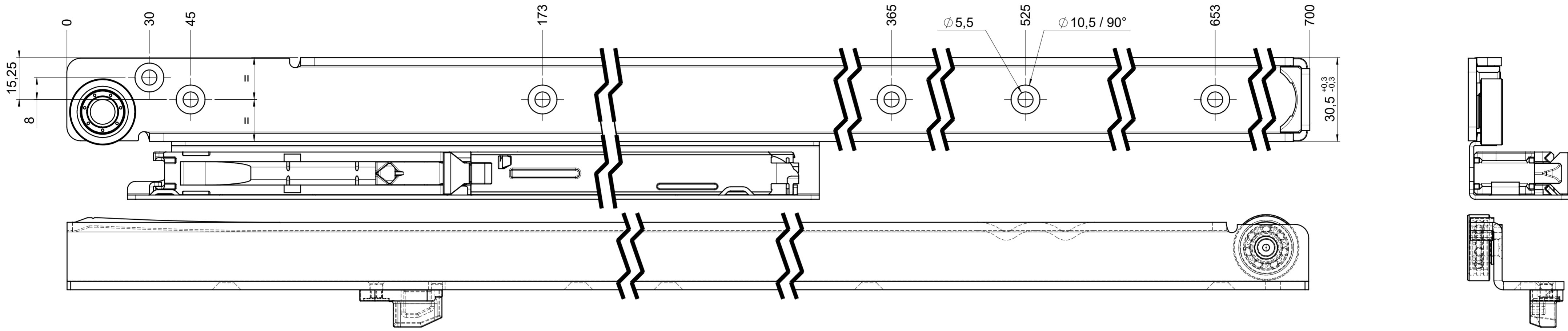
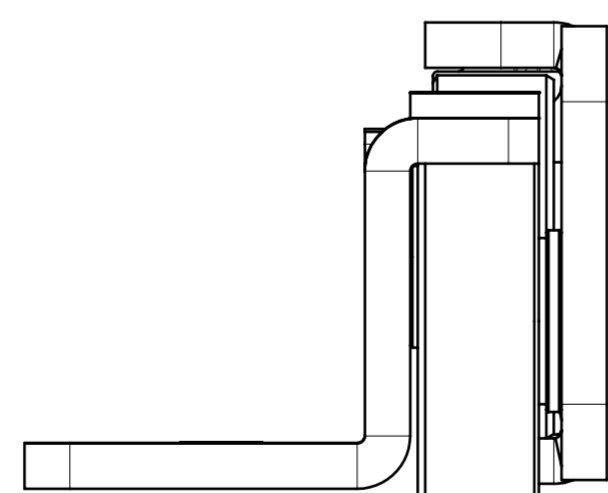

right without ECD

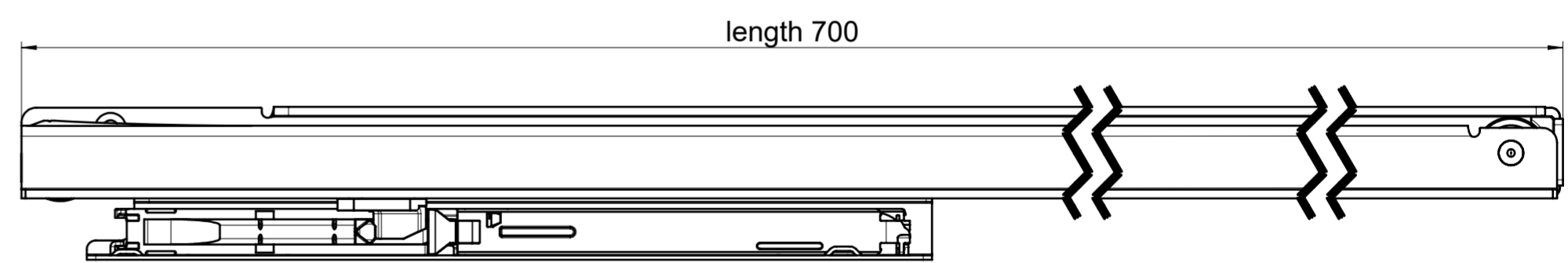

final approval

customer name:

signed by:

date:

all dimensions in mm				DIN ISO 128-30 missing dimensions see 3D = theor. intersection	
This drawing remains our property and may not be multiplied neither be disclosed to third parties (§§1,3 and 5 from the copyright Act (UrhG)) covered according to DIN ISO 16016					
scale: 1:1		surface:		material, semi finished parts: STEEL (technical requirements Fulterer)	
drawn 01-05-2023		date		description: FR 206 / 700 EN (mm) regular-extension drawerslide / bottom mount	
proven 08-05-2023		name		drawing number: 206.700-GA.L529	
		pr		replaces version date:	
				Fulterer AG & Co KG A-6890 Lustenau / Austria Fulterer AG CH-9430 St. Margrethen	
ind.		changes		date na.	