

drawn left

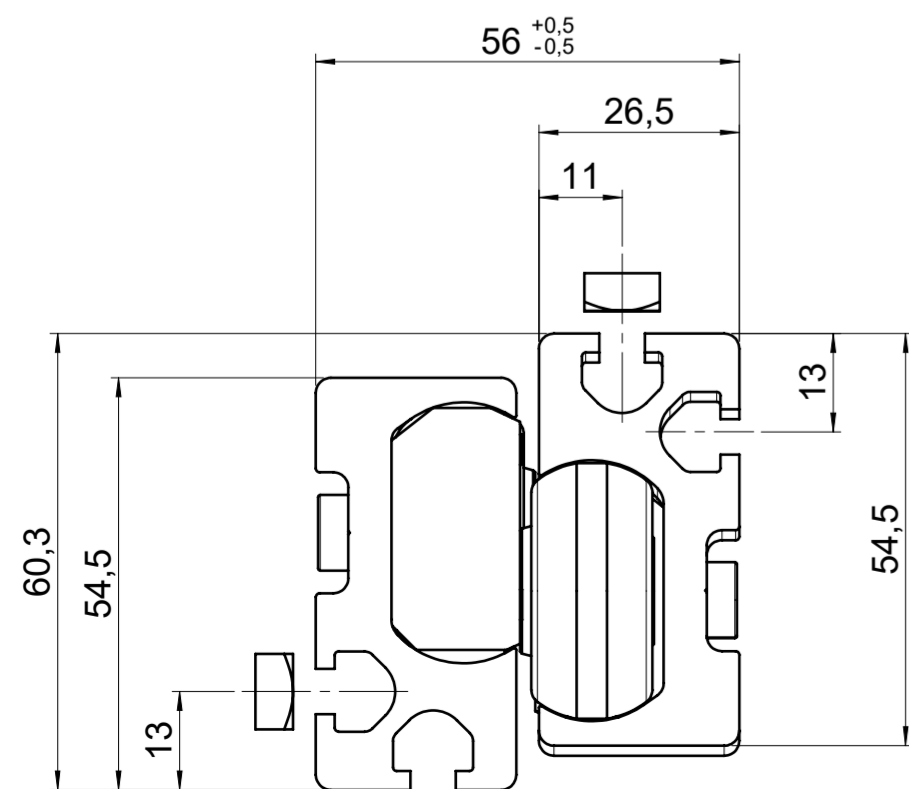
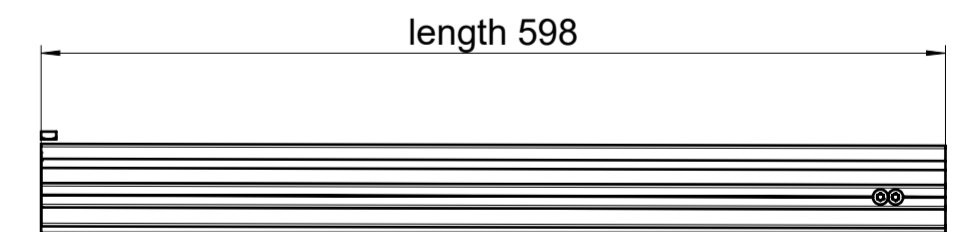
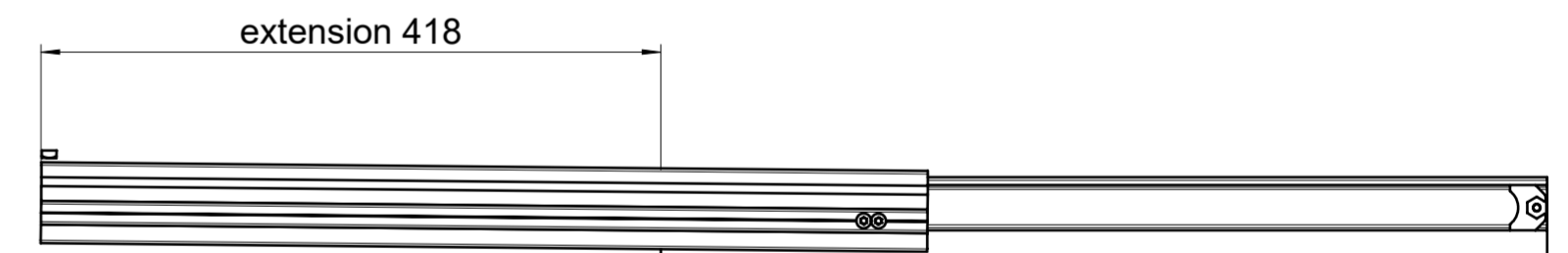
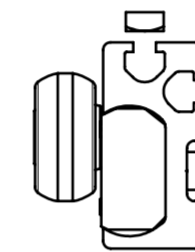
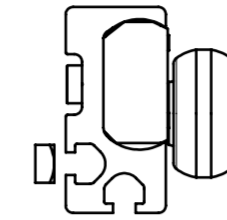
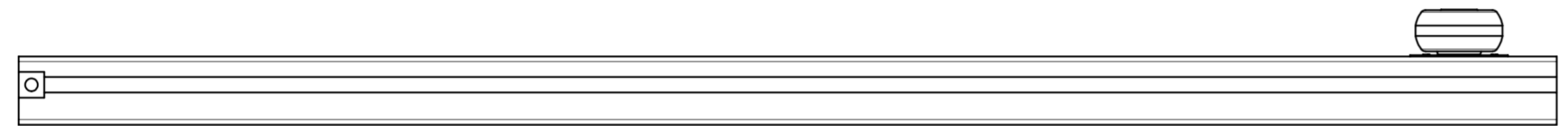
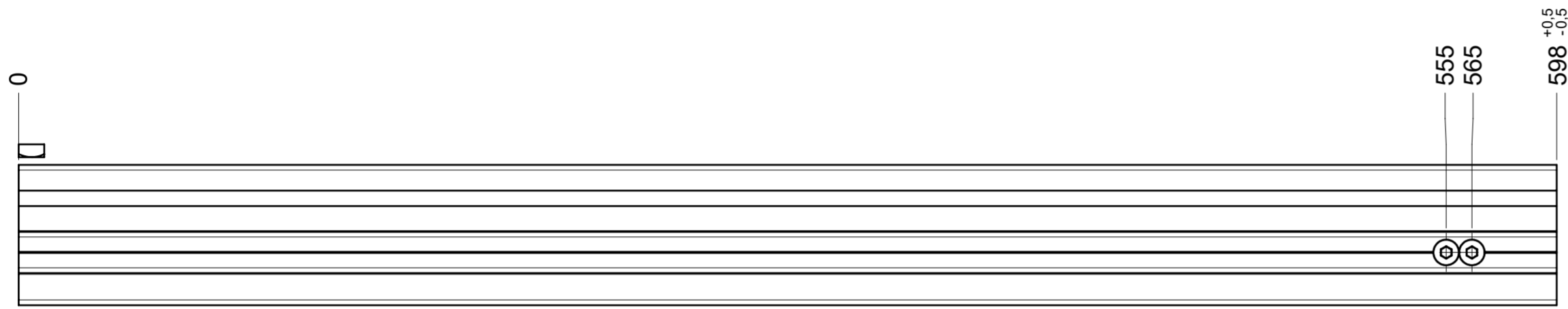
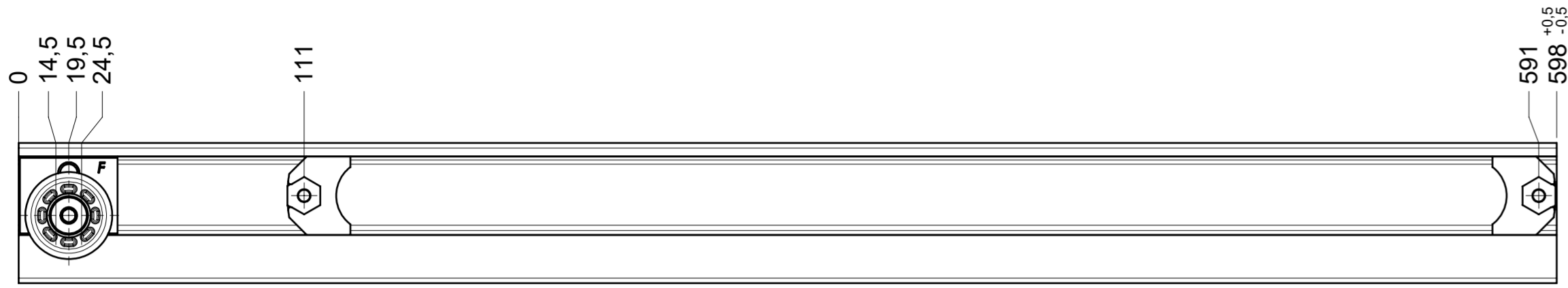

final approval

customer name:

signed by:

date:

all dimensions in mm

DIN ISO 128-30
missing dimensions see 3D
= theor. intersection

This drawing remains our property and may not be multiplied neither be disclosed to third parties (§§1,3 and 5 from the copyright Act (UrhG)) covered according to DIN ISO 16016				scale: 1:2	surface:	material, semi finished parts: CS (technical requirements Fulterer)	A2
(k)				date	name	description: FR 9000 / 60 EN (mm) progressive-action full-extension drawerslide / side mount	drawing number: 9000.600-GA.0000.li replaces version date:
(l)			drawn 01-02-2023	ex			
(h)			proven 01-03-2023	pr			
(g)							
(f)							
(e)							
(d)							
(c)							
(b)							
(a)							
ind.	changes	date	na.				

drawn right

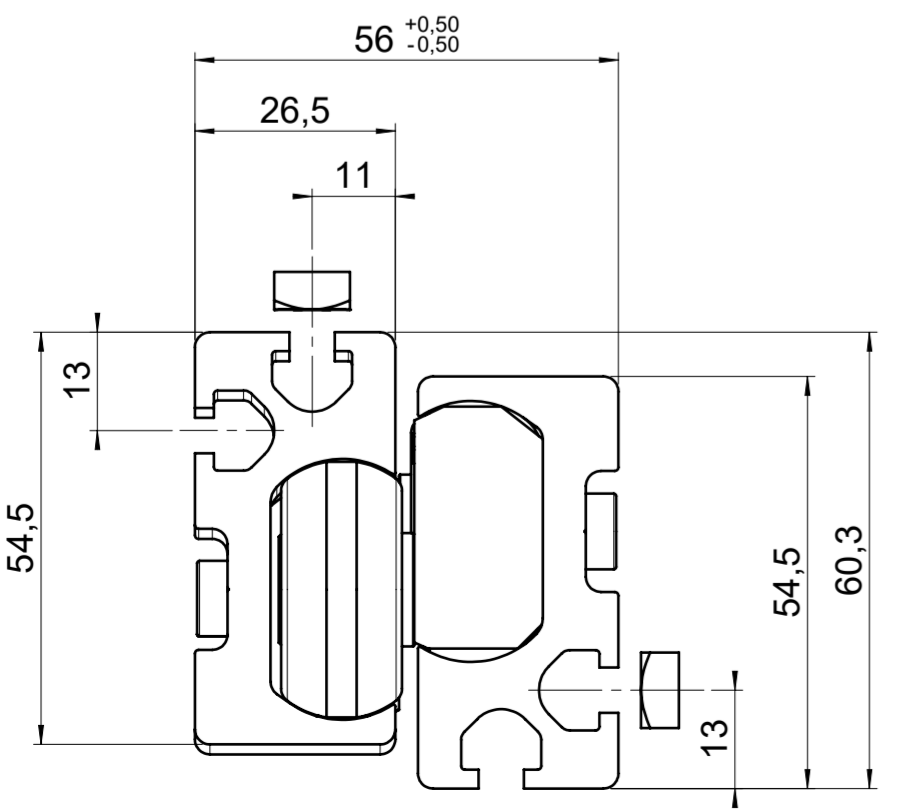
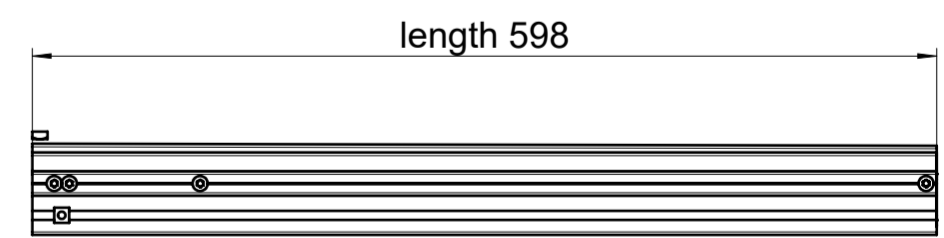
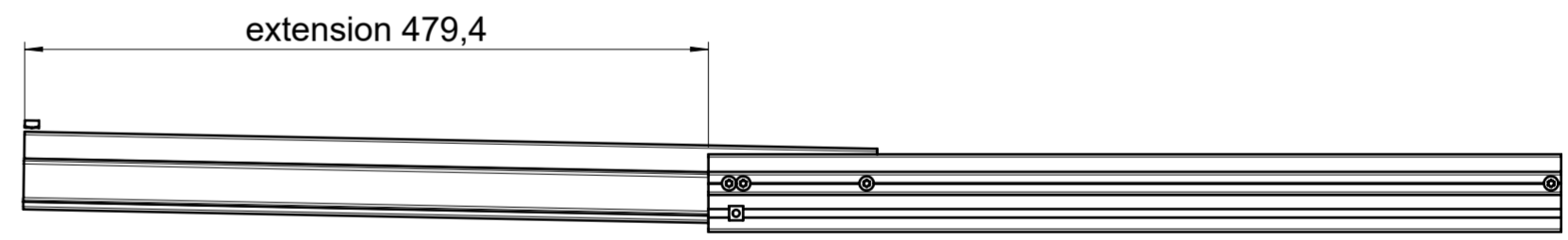
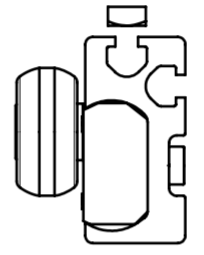
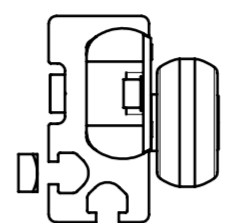
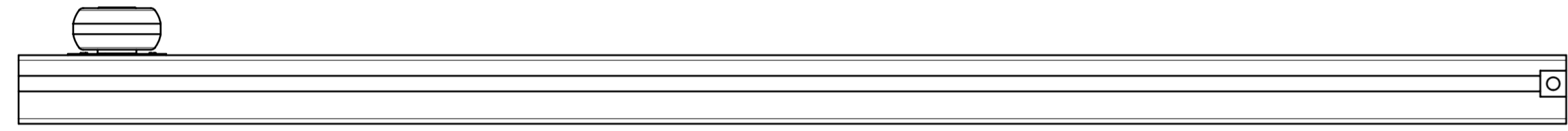
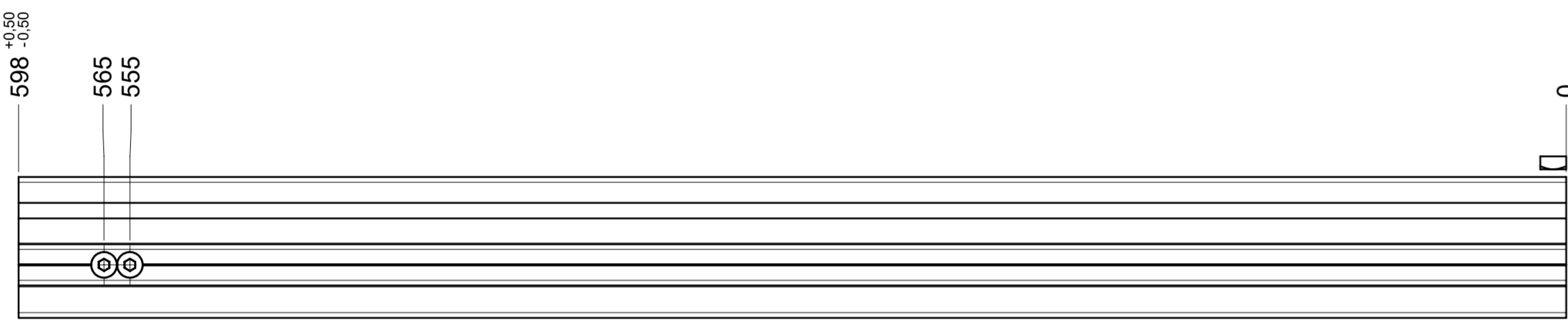
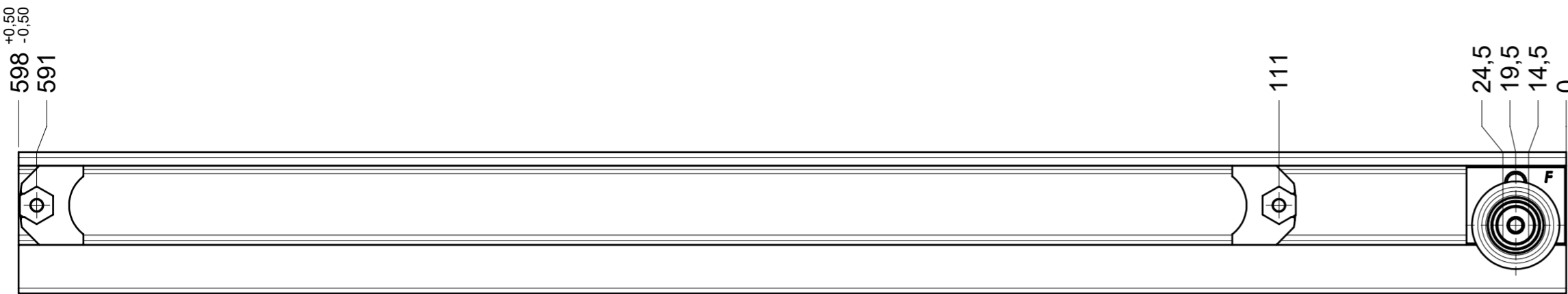

final approval

customer name:

signed by:

date:

all dimensions in mm				DIN ISO 128-30 missing dimensions see 3D = theor. intersection	
This drawing remains our property and may not be multiplied neither be disclosed to third parties (§§1,3 and 5 from the copyright Act (UrhG)) covered according to DIN ISO 16016					
scale: 1:2		surface:		material, semi finished parts: CS (technical requirements Fulterer)	
drawn 01-02-2023		date 01-02-2023		name ex	
proven 01-03-2023		date 01-03-2023		name pr	
				description: FR 9000 / 60 EN (mm) progressive-action full-extension drawerslide / side mount	
				drawing number: 9000.600-GA.0000.re	
				replaces version date:	
				Fulterer AG & Co KG A-6890 Lustenau / Austria	
				Fulterer AG CH-9430 St. Margrethen	
ind.	changes	date	na.		