

CABINET MOUNTING HOLES

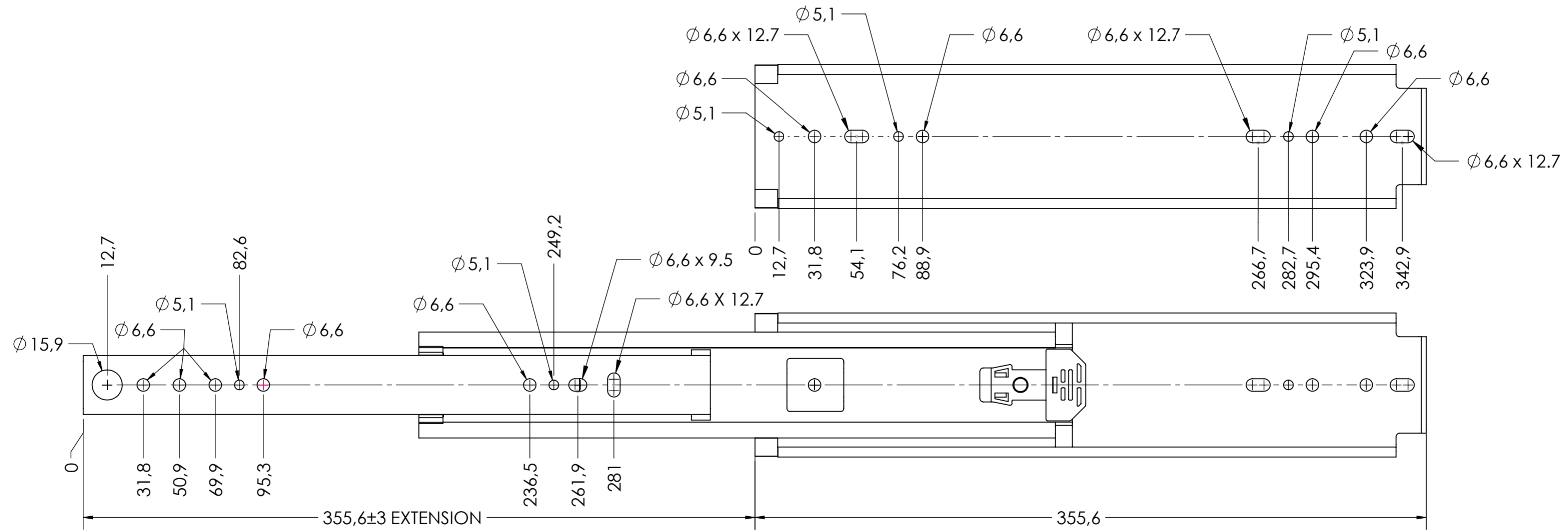

RECOMMENDED HARDWARE:
 CABINET- M6 OR 1/4 BUTTON HEAD SCREWS
 DRAWER- M6 OR 1/4 BUTTON HEAD SCREWS

general tolerances		DIN ISO 128-30 missing dimensions see 3D = theor. intersection	
ISO 2768-m			
This drawing remains our property and may not be multiplied neither be disclosed to third parties (§§1,3 and 5 from the copyright Act (UrhG)) covered according to DIN ISO 16016			
(k)	scale:	1:2	surface:
(l)	date	27-07-2018	name
(m)	drawn	HB	description:
(n)	proven	00-00-0000	00
(o)	Fulterer		FULL EXTENSION SIDE MOUNT
(p)			HEAVY DUTY DRAWER SLIDE
(q)	Fulterer AG & Co KG		NON-DISCONNECT
(r)	A-6890 Lustenau / Austria		drawing number:
(s)	Fulterer AG		5400.14-GA.T018
(t)	CH-9430 St. Margrethen		replaces version date:
(u)	UPDATE TITLE BLOCK	19-03-2019	HB
(v)	changes	date	na.