

SCALE 1:1

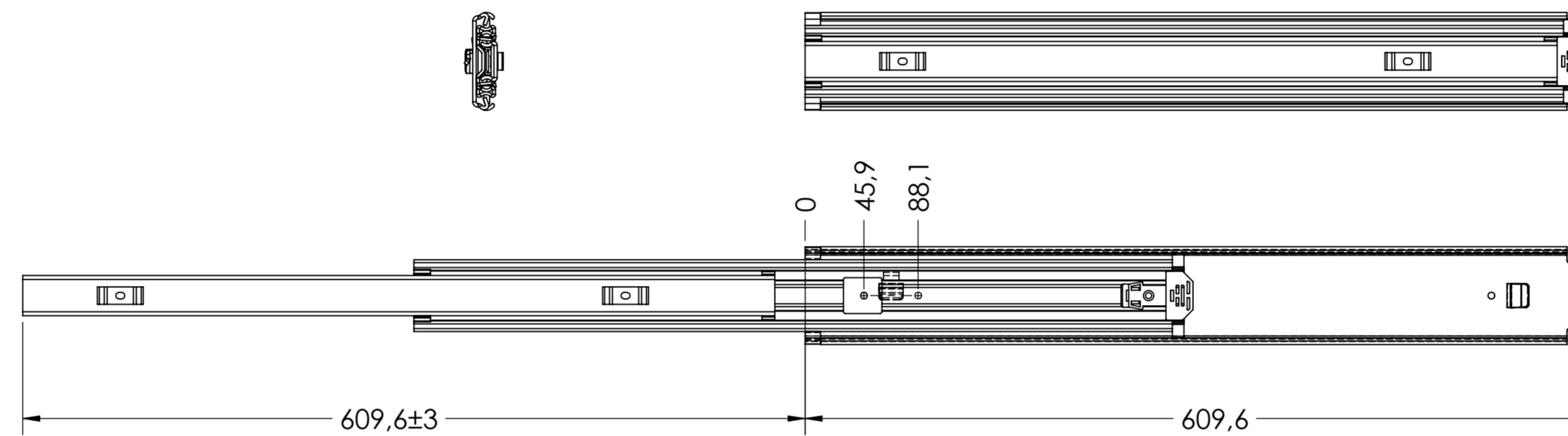

DRAWER MOUNTING CUTOUTS

CABINET MOUNTING CUTOUTS

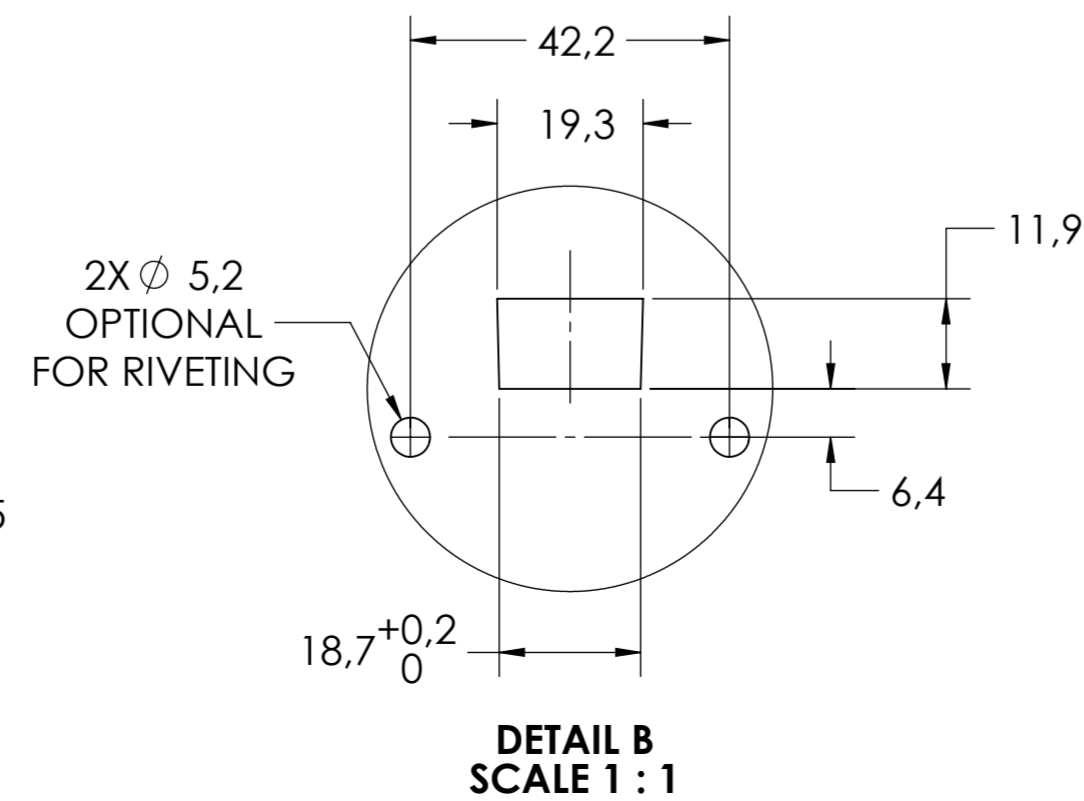
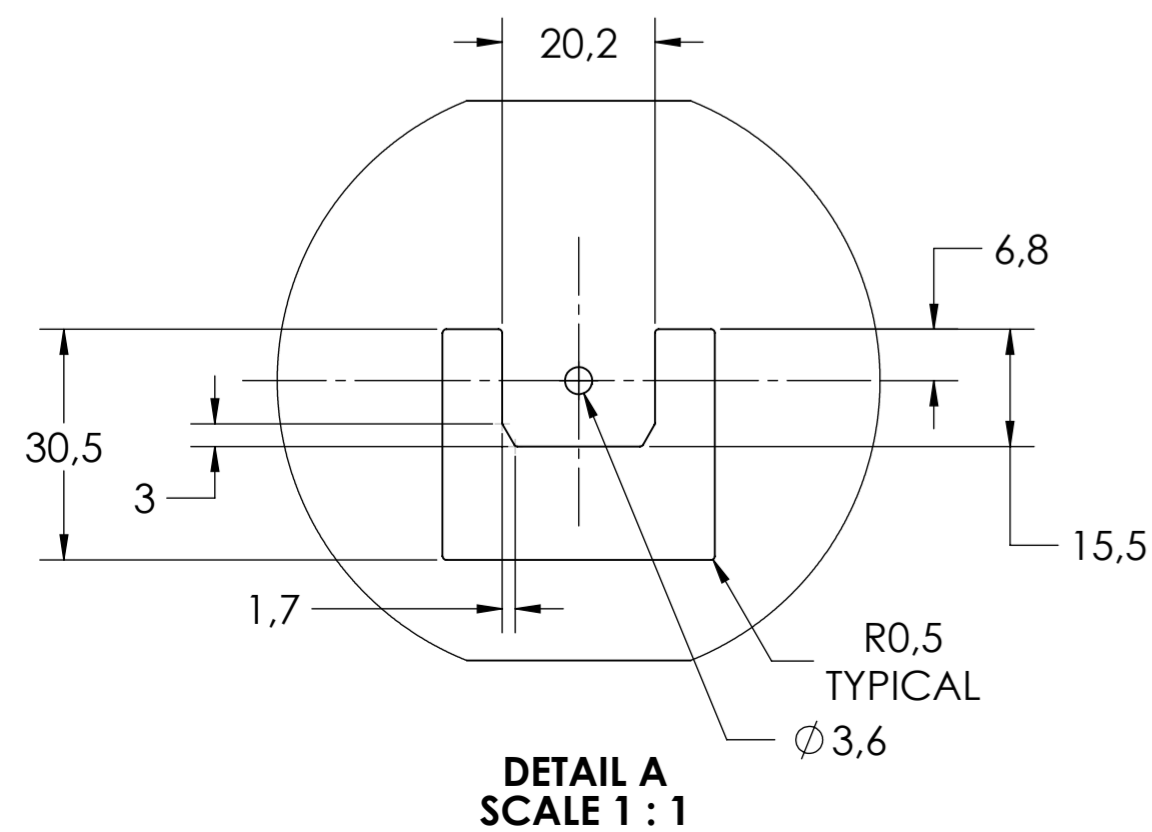
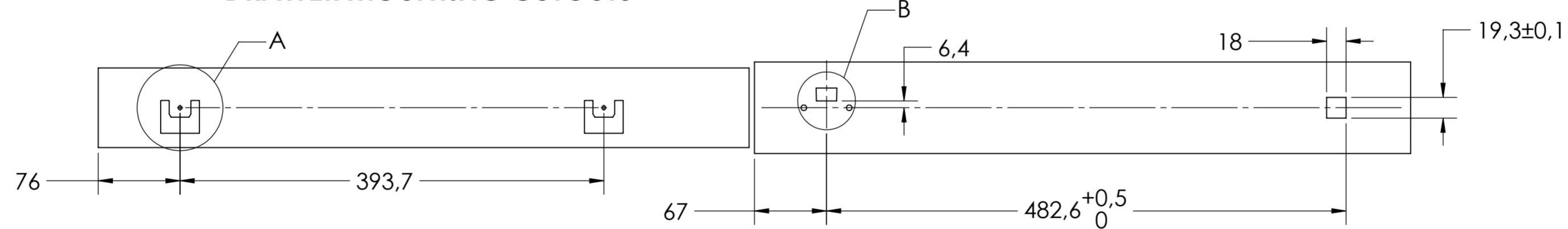

general tolerances		DIN ISO 128-30 missing dimensions see 3D = theor. intersection	
ISO 2768-m			
This drawing remains our property and may not be multiplied neither be disclosed to third parties (§§1,3 and 5 from the copyright Act (UrhG)) covered according to DIN ISO 16016			
scale: 1:4		surface: A2	
drawn: 31-05-2019		name: HB	
proven: 00-00-0000		00	
		material, semi finished parts: STEEL (technical requirements Fulterer)	
		description: SIDE MOUNT FULL EXTENSION HD SMT SLIDE FOR 1.9mm THICK MATERIAL NON-DISCONNECT	
drawing number: 5400.24-GA.T115		replaces version date:	
ind.	changes	date	na.